



Hazardous voltage.

Warning: High voltage. Do not touch the terminals.



Warning: High voltage. Do not touch the terminals.

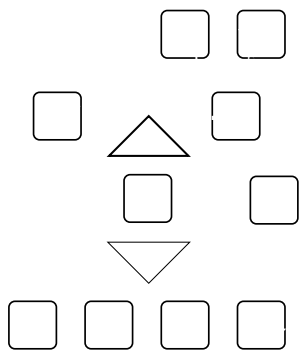

Step 2: Remove the MCB 109 Option Card



Figure 4.

Step 3: Install terminal block.

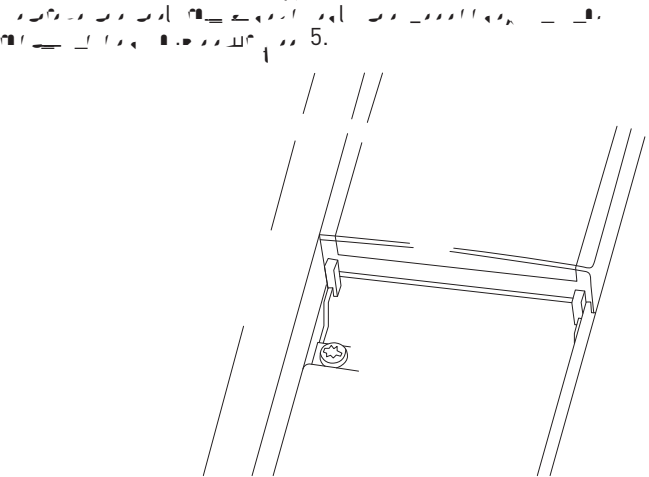



5

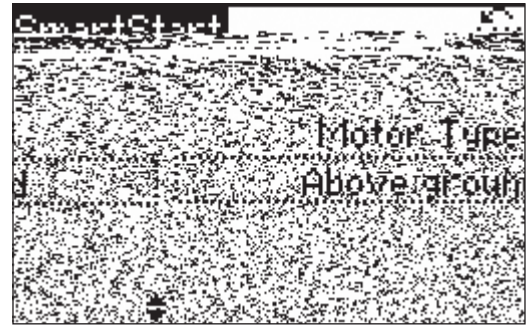
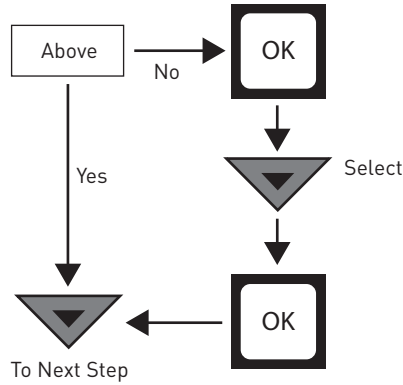

6

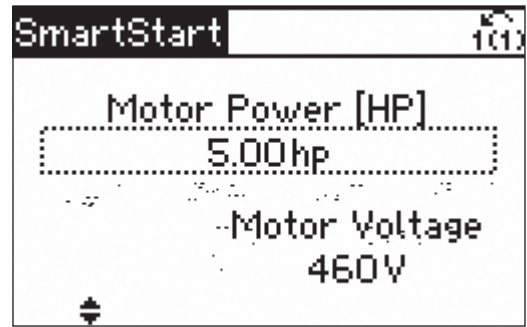
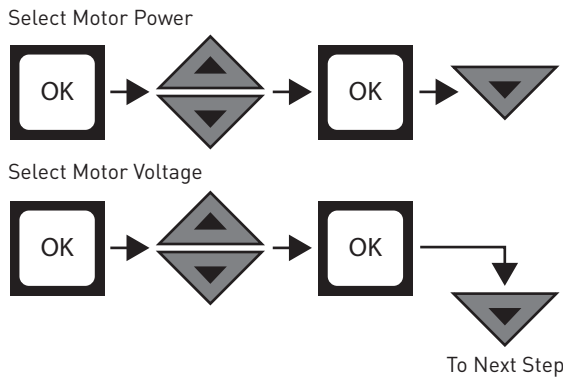

7

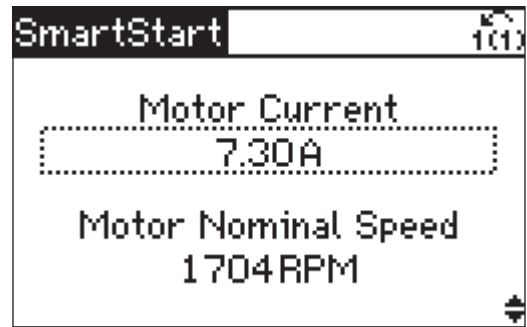
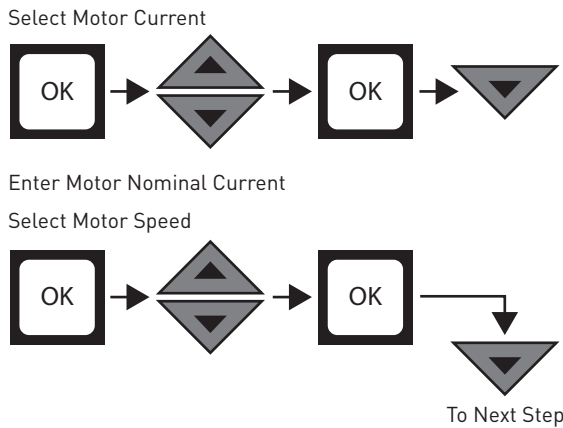

8

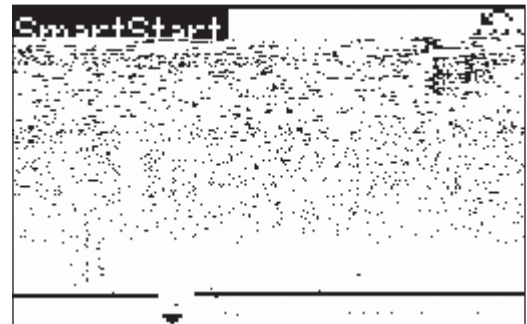

9



To Next Step

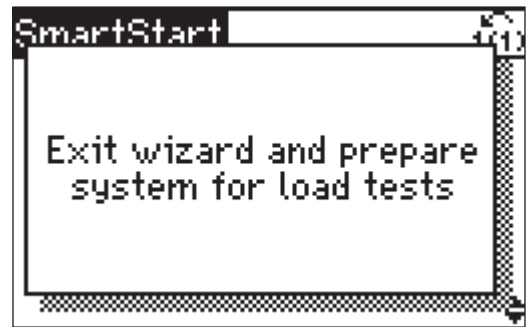

Handwritten notes for step 9, including a large '9' and some illegible scribbles.

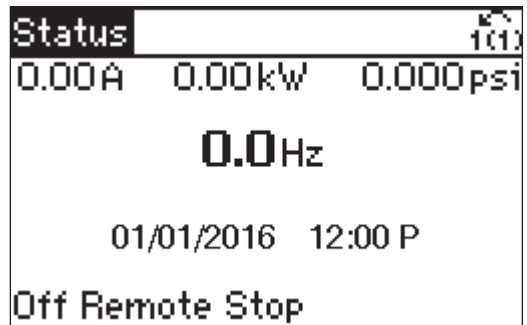

10

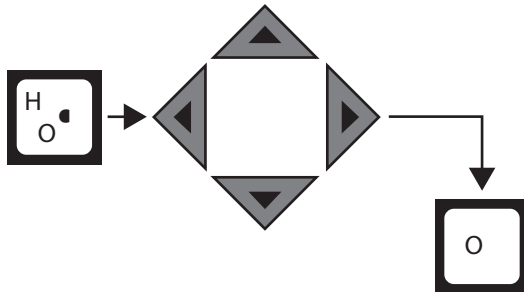

Handwritten notes for step 10, including a large '10' and some illegible scribbles.

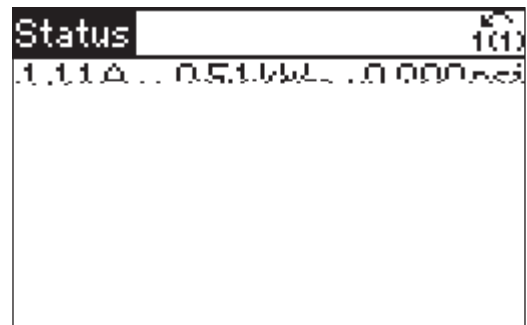

11



To SmartStart

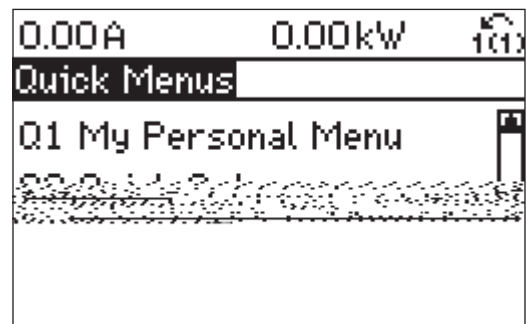





---

Adjust Live Zero Settings

---

20



Status	f(1)	
12.4A	5.76kW	0.000psi
<b>6.6Hz</b>		
01/01/2016 12:00 P		
Auto Remote Ramping		

---

21

1. The Live Zero button is located on the right side of the screen. Pressing this button will allow you to adjust the live zero settings for the selected channel.





0-20, 1611, 30, 50, 0-2\*

A1

0-20, 1611, 30, 50, 0-2\*

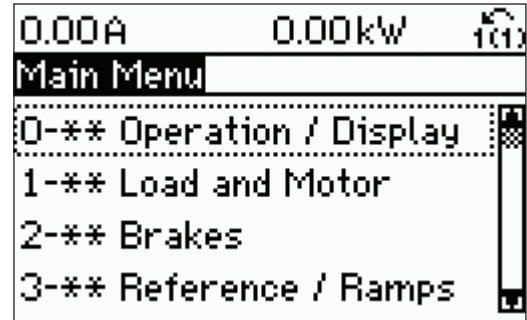

A2

0-20, 1611, 30, 50, 0-2\*



A3

0-20, 1611, 30, 50, 0-2\*

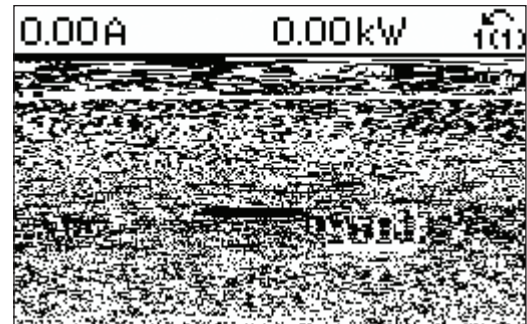

A4

0-20, 1611, 30, 50, 0-2\*

A5

0-20, 1611, 30, 50, 0-2\*

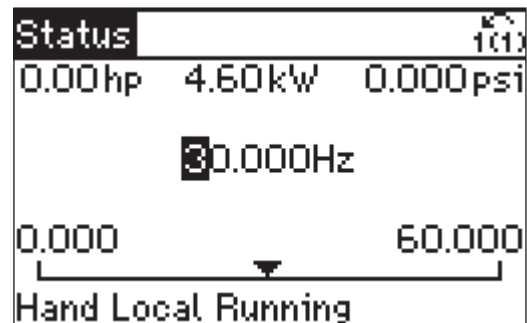

**A6**

Press the **Q** button on the remote control.



22-35

**A7**

Press the **Q** button on the remote control.

22-37

22-3

**A8**

Press the **Q** button on the remote control.

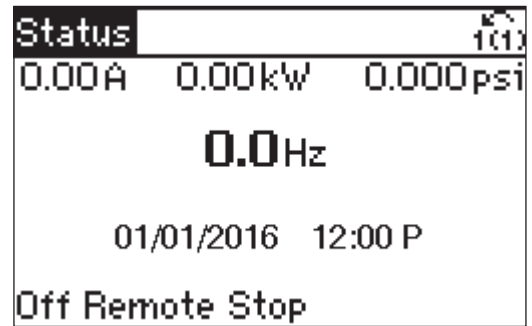

**A9**



To SmartStart

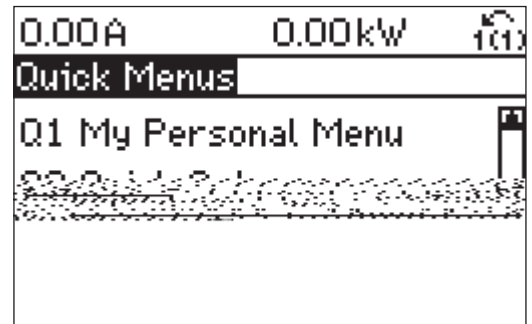

**A10**



To Next Step

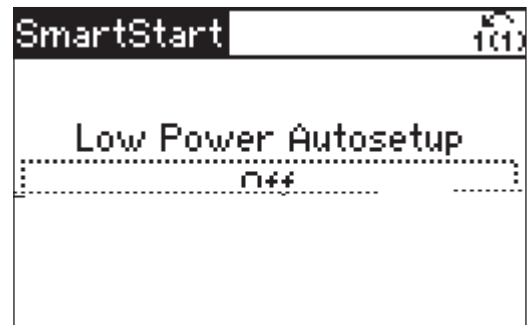

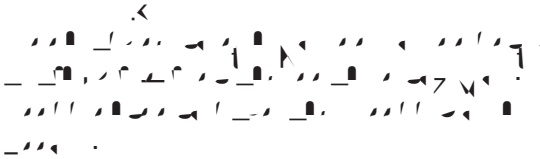
**A11** 

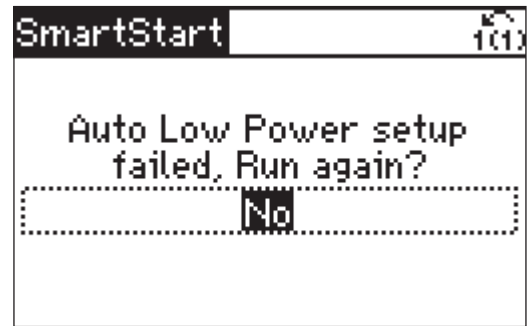

**A12**

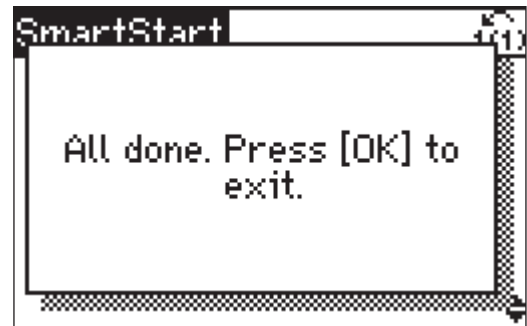

**Adjust Sleep Parameters**

**A13** 

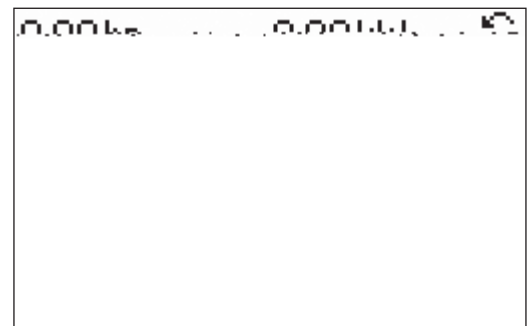

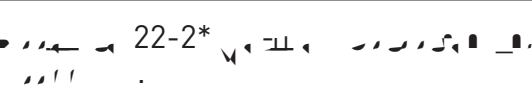
**A14** 

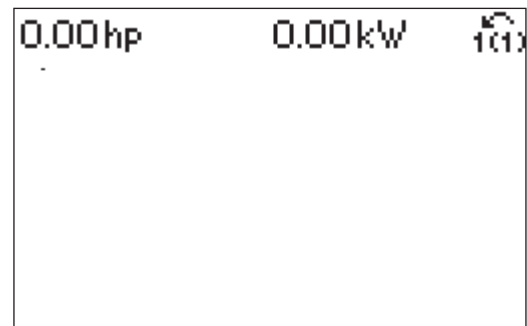

**A15** 22-21

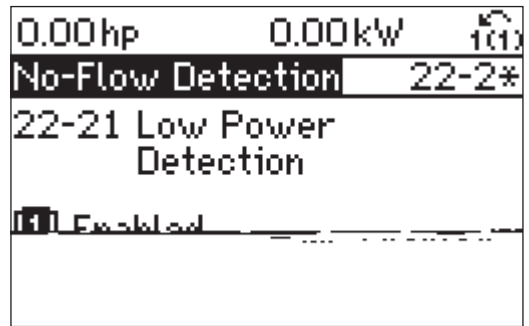

**A16** 22-3\*

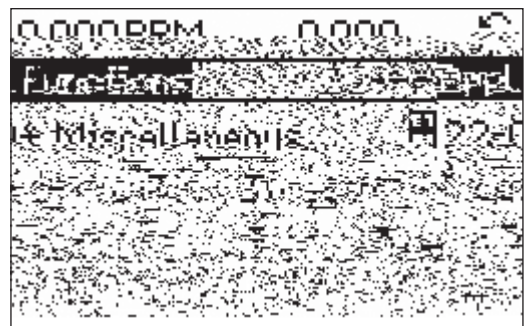

**A17** 22-37

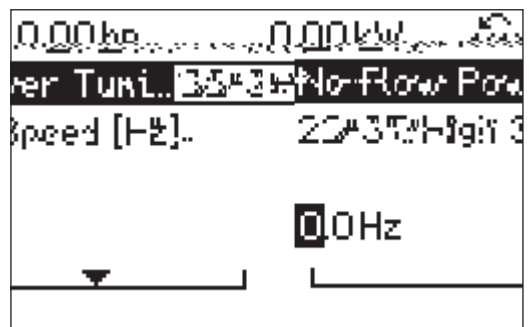

**A18** 22-3

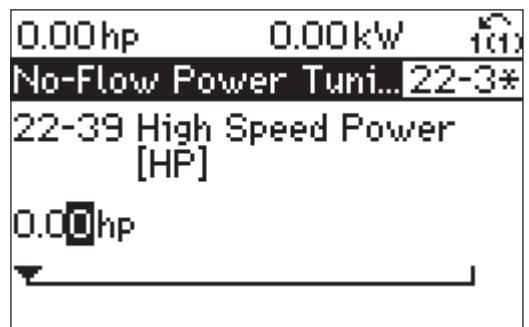

**A19** 22-33 30

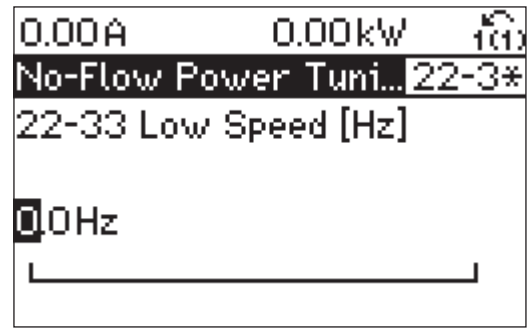

**A20** 22-35 6

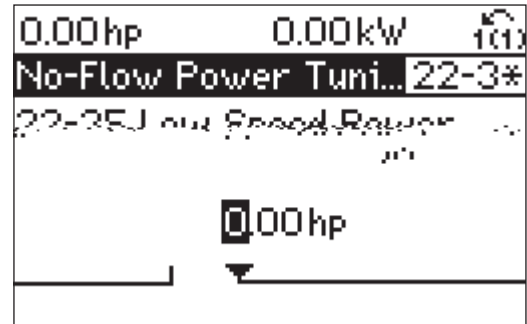

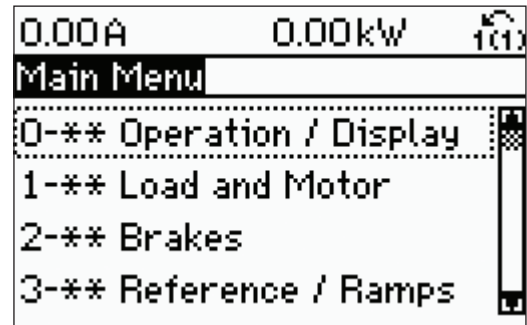

**A21** 0-\*\*

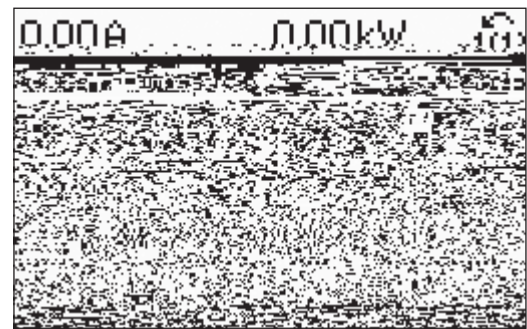

**A22** 0-2\*

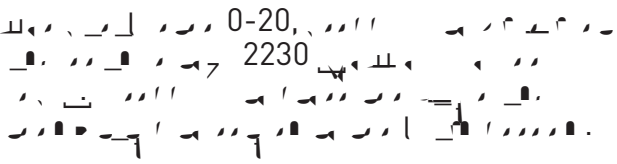
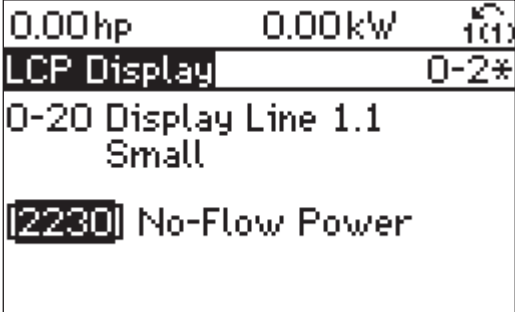

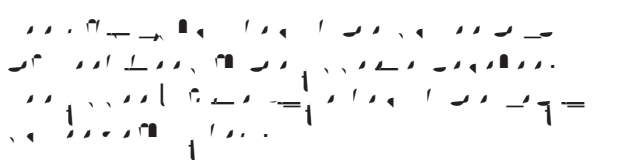
**A23**  

**A24**  

**A25** 

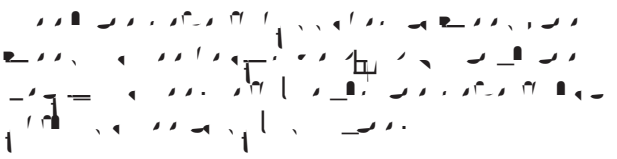
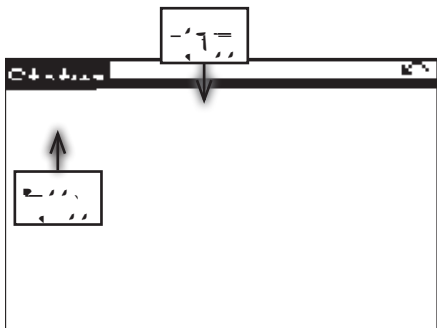
**A26** Sleep (No Flow)  

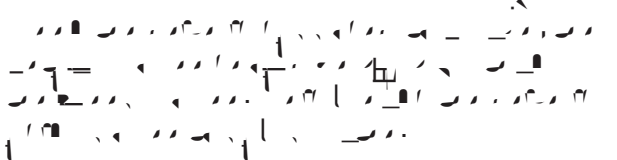
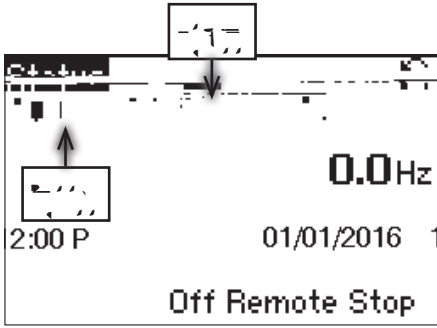
Awake (with Low Flow)  

**A27** 

**A28** SLEEPS USING WATER

22-31  
100% → 6%.

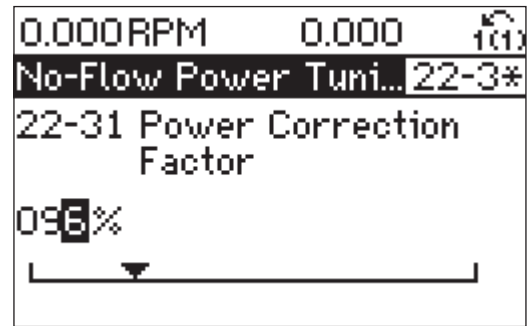

**A29**

22-31

**A30** WON'T SLEEP WHEN NOT USING WATER

22-31  
100% → 104%.



**A31**

22-31

**A32**

0-\*\*

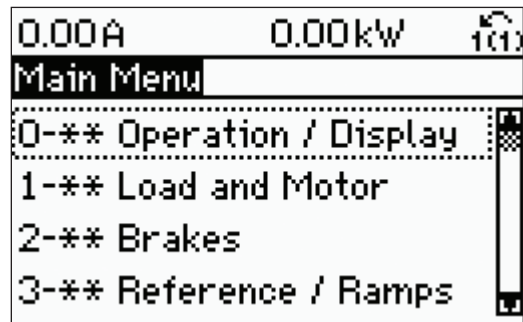

**A33**

0-2\*

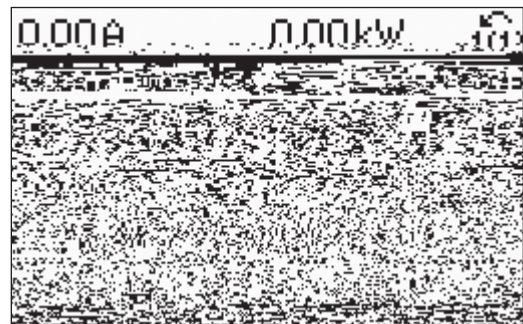

**A34** 0-20, 1614

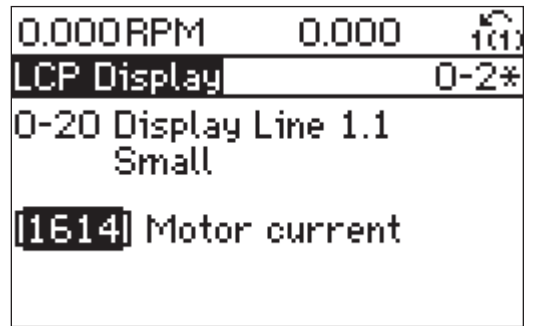

**A35** (3)

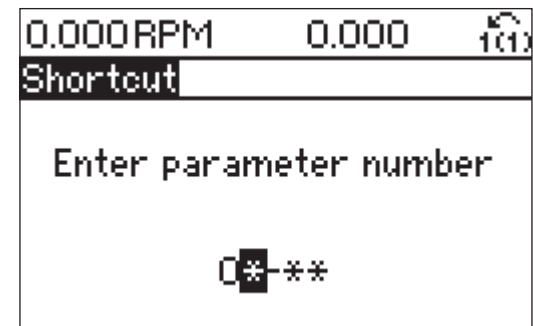

**A36** 06-00

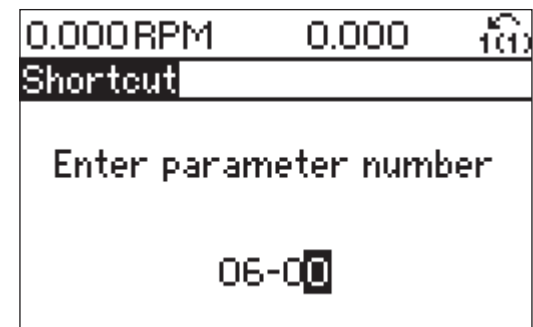

**A37** 000 01, 6-01

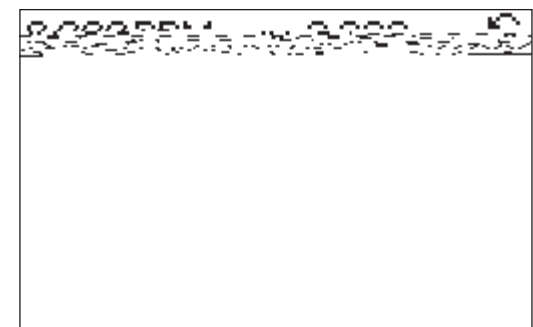



**A38** 



**A39**



<b>Status</b>		
12.4A	5.76kW	0.000psi
<b>6.6Hz</b>		
01/01/2016 12:00 P		
Auto Remote Ramping		

ብሎ ይገለጻል ለሁሉም ጊዜዎች ለሁሉም ጊዜዎች ለሁሉም ጊዜዎች ለሁሉም ጊዜዎች

ታላቁ ወይን ገቢዎችን ለማረጋገጥ ለሚፈልጉት

