

†

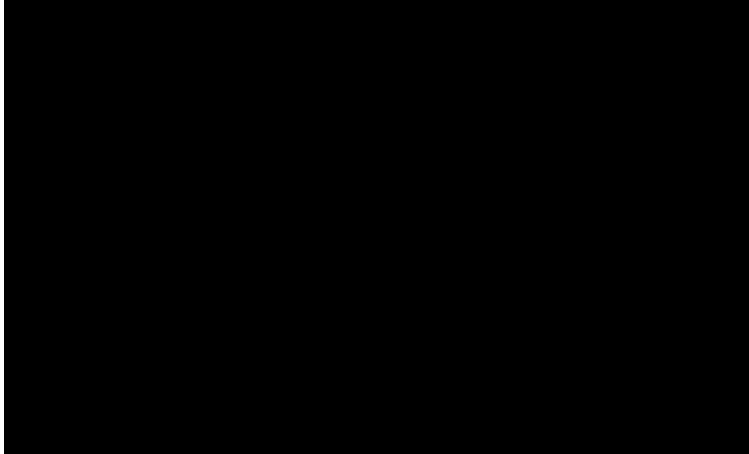

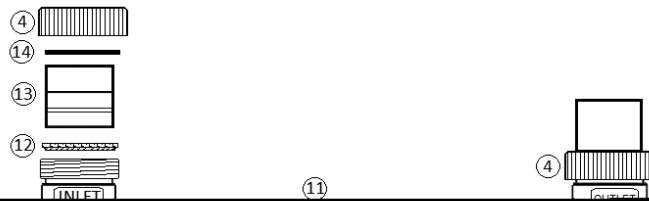
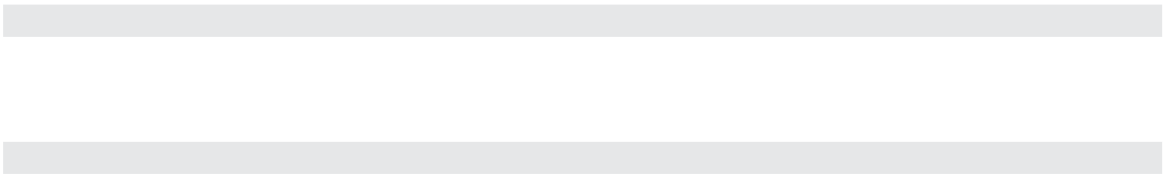
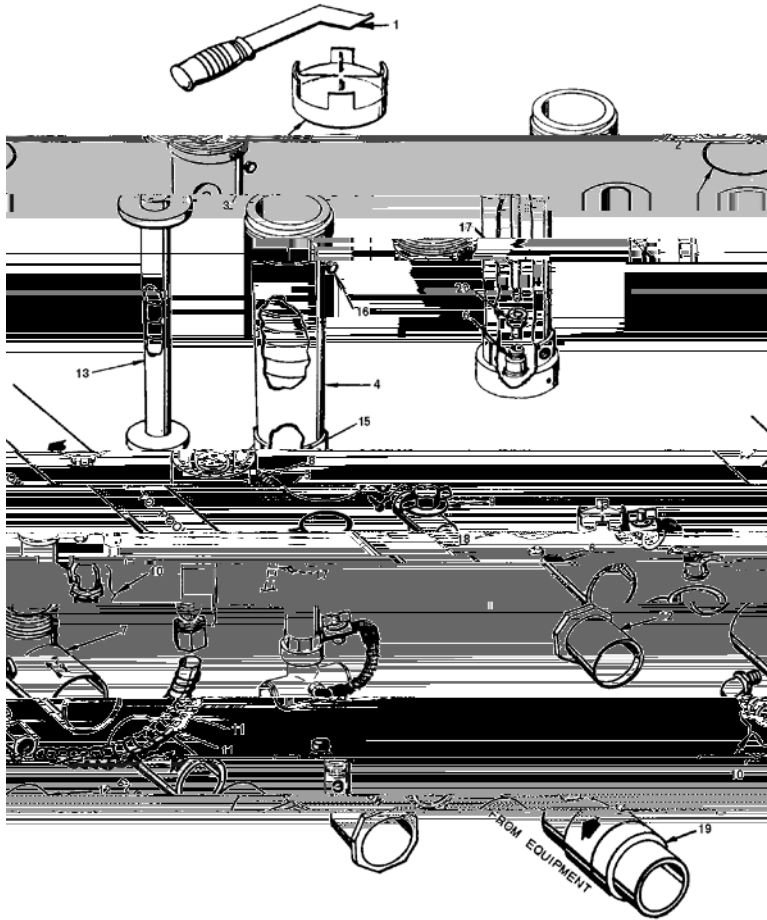

Order No.: R171096

Model No.: 320

Description: IN-LINE AUTOMATIC FEEDER

1	Opt.	R172052	Cap wrench	44.96	54.02
2	1	R172008W	3 in. threaded cap - white	26.78	32.18
3	1	R172009Z	O-ring, cap	10.40	12.50
4	1	R172321	#320 Body only (new style)	80.58	96.82
5	1	R01052	Lock screw	2.17	2.61
6	1	R172248Z	Check valve	CALL	CALL
7	1	R172317	Diverter tee 1-1/2 NPT x 2 in. slip	39.88	47.92
8	1	R172256Z	1/2 in. x Short MPT nipple	CALL	CALL
9	1	R172086Z	1/2 in. Control valve	77.23	92.80
10	2	R172272Z	1/2 in. NPT x tube 90° ELL w/nut	11.00	13.22
10	Opt.	R172274Z	Compression nut only (for R172272Z)	CALL	CALL

Product on page 296.

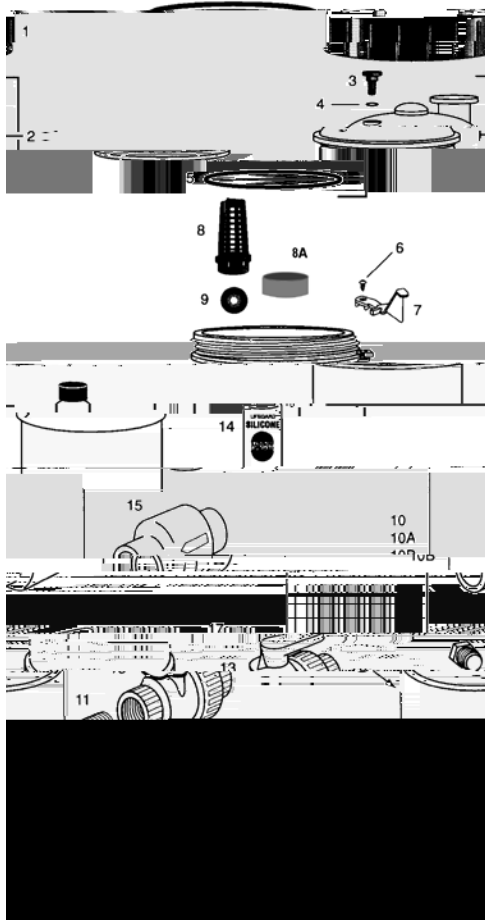

Order No.: R171215, R171230, R171240
 Model No.: HC-3315, HC-3330, HC-3340
 Description: HIGH CAPACITY AUTOMATIC FEEDER

1	1	R172214	Lock ring	26.29	31.59
2	1	R172385D	Lid assembly complete	46.41	55.77
3	1	R172224XZ	Vent valve	CALL	CALL
4	1	R172221Z	O-ring vent valve	CALL	CALL
5	1	R172240Z	O-ring lid to housing	CALL	CALL
6	1	R172375	Lock screw	2.17	2.61
7	1	R172374	Lock spring	8.56	10.29
8	1	R175251	Screen	8.66	10.41
8A	1	R171919	Check Valve Seat	CALL	CALL
9	1	R172435	Check ball	2.23	2.68
11	2	R270484	1 in. Close nipple	8.56	10.29
12	1	R270531	1 in. Threaded union	26.87	32.29
13	1	R172439	Control valve	124.29	149.35
14	1	R172036Z	Silicone lubricant, 3/4 oz.	14.55	17.48
15	Opt.	R172288	1-1/2 in.-2 in. Check valve	60.34	72.50
16	1	R175009	Hose Bib w/t Handle 1/2 in.	26.45	31.78
17	1	R172134	1/2 in. threaded plug	9.43	11.33

NOT SHOWN

		R172082	Flow rate indicator	CALL	CALL
--	--	---------	---------------------	------	------

WARNING:

Order No.: R172087 10 IN. EXTENSION COMPLETE
 Order No.: R172283 20 IN. EXTENSION COMPLETE

1	1	R172078	Lockscrew (bottom collar)	2.17	2.61
2	1	R17209Z	O-ring	10.40	12.50

Order No.: R172080Z Description: FLOW INDICATOR

1	1	R172392	Access plug 1/4 in. MPT	8.56	10.29
2	1	R172393	O-ring	8.56	10.29
3	1	R172020	Check valve	7.06	8.48
4	1				

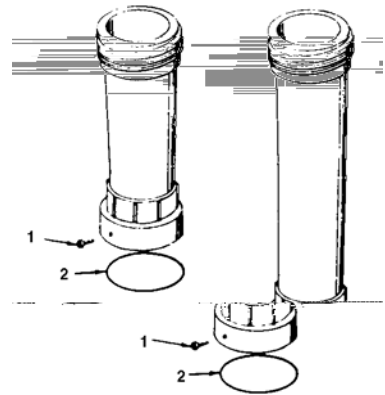

R172087 R172283



R172080Z

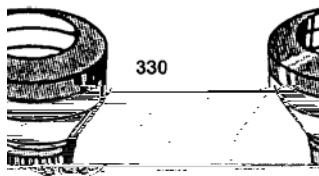

R171086

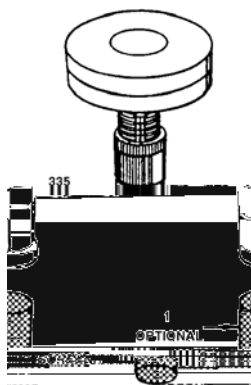

R171090

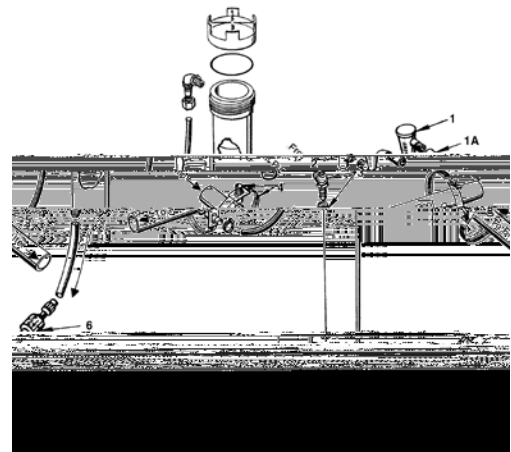

R172627

Product on page 297.

